

1 Features and Benefits

- ▲ Digital output
- ▲ Stable over the entire temperature range
- ▲ Wide operating voltage range: 4.5V ~ 24V
- ▲ Strong resistance to mechanical stress
- ▲ Non-contact output, safety and reliable
- ▲ Directly drive the coils of DC motor (Fan)
- ▲ Immunity to logic race condition
- ▲ Short switch time and good switch sensitivity
- ▲ TO-94 package
- ▲ Developed according to the EU RoHS & REACH

2 Application Examples

- ▲ Automotive electronics, Consumer electronics and Industrial electronics
- ▲ Water flow sensing
- ▲ Electronic steering column lock
- ▲ Door latch system
- ▲ Seat adjustment
- ▲ Speed measurement and tachometer
- ▲ Motor control
- ▲ Brushless DC motor

3 Selection Guide

Part Number	Packing	Mounting	Operating, To	B _{RP} (Min)	B _{OP} (Max)
AH4158	Anti-static bag, 1000 pieces/bag	4-pin SIP through hole	-40°C ~ 85°C	3.0mT	20.0mT

NOTE: Hall ICs are soldered tin brazing for assembly, and wave soldering of SOT-23-3L and SOT-89 surface-mounted components poses a risk of failure.

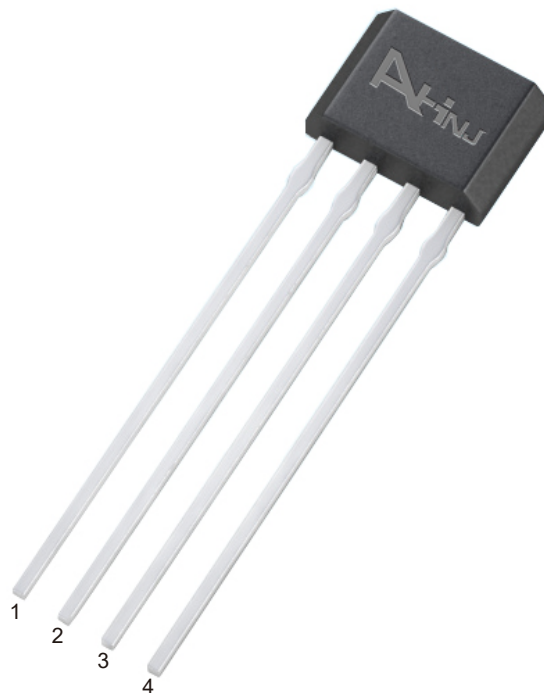

4 General Description

AH4158 Hall Sensor is a kind of unipolar Hall switch with two complementary outputs. It is particularly suitable for double coil DC motor, double coil DC fan, speed measurement and rotation control. The sensor chip integrated bandgap reference voltage source, Hall voltage generator, signal amplifier, hysteresis controller, reverse voltage protection diode, and circuit units such as an open-collector output driver with two complementary outputs with a sink current of 300mA. High-performance bandgap reference voltage source ensures consistent sensitivity of the sensor over a wide temperature range. Reverse voltage protection diodes avoid reverse power failures.

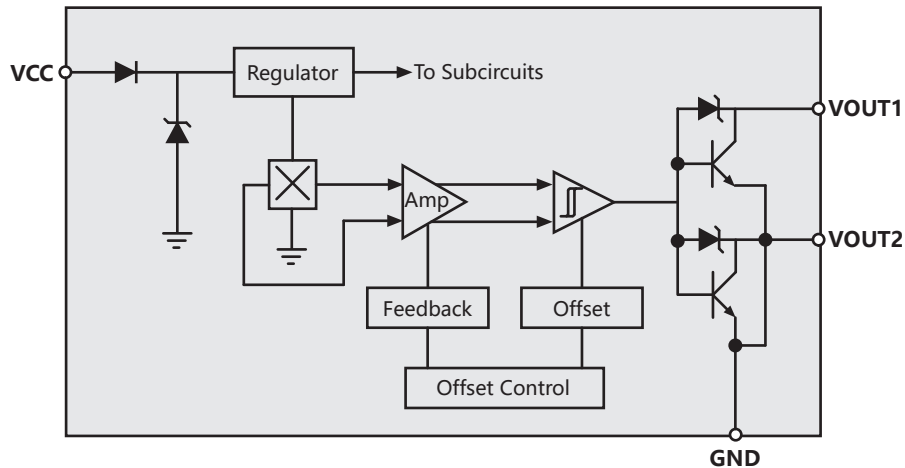

5 Terminal List

TO-94

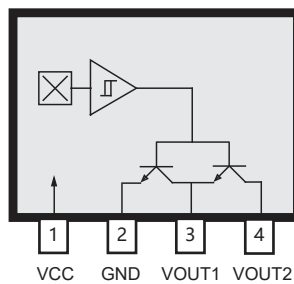

Name	Description	Number
VCC	Power Supply Input	1
GND	Ground	2
VOUT1	Output 1	3
VOUT2	Output 2	4

6 Absolute Maximum Ratings

Characteristic	Symbol	Note	Rating	Unit
Supply Voltage	V_{CC}		28	V
Reverse Supply Voltage	V_{ROUT}		-0.5	V
Output Current	$I_{OUTSINK}$		500	mA
Magnetic Flux Density	B		Unlimited	mT
Operating Temperature	T_o	E	-40 ~ 85	°C
Maximum Junction Temperature	$T_{J(max)}$	Too high a T_J could lead to electrical or thermal breakdown	165	°C
Storage Temperature	T_{stg}		-50 ~ 160	°C
ESD sensitivity – HBM	-		6	kV

NOTE 1. Human Body Model according to AEC-Q100-002 standard.

7 Electrical Operating Characteristics

valid through the full operating temperature range; unless otherwise specified

Characteristic	Symbol	Test Conditions	Min.	Typ.	Max.	Unit
Supply Voltage	V_{CC}	Operating, $T_J < 165^\circ\text{C}$	4.5	-	24	V
High-level Output Voltage	V_{OH}	$V_{CC}=24\text{V}$, $R_L=10\text{k}\Omega$, $B < B_{RP}$	23.5	-	24	V
Low-level Output Voltage	V_{OL}	$I_{OUTMAX}=25\text{mA}$, $B > B_{OP}$	0	-	0.5	V
Supply Current	I_{CC}	$V_{CC}=24\text{V}$	-	6.0	8.0	mA
Output leakage Current	I_{OUTOFF}	$V_{OUT}=24\text{V}$, $B < B_{RP}$	-	-	10	μA
Power-On Time	t_{PO}		-	-	30	μs
Output-Rise Time	t_R	$V_{CC}=12\text{V}$, $R_L=1.2\text{k}\Omega$, $C=12\text{pF}$	-	-	2	μs
Output-Fall Time	t_F	$V_{CC}=12\text{V}$, $R_L=1.2\text{k}\Omega$, $C=12\text{pF}$	-	-	2	μs

NOTE 1. Power-On Time, t_{PO} , is defined as: the time it takes for the output voltage to settle within $\pm 10\%$ of its steady state value under an applied magnetic field, after the power supply has reached its minimum specified operating voltage, V_{CC} (min).

8 Magnetic Operating Characteristics

valid through the full operating temperature range; unless otherwise specified

Characteristic	Symbol	Test Conditions	Min.	Typ.	Max.	Unit
Operating Point	B_{OP}	Operating, $T_J < 165^\circ\text{C}$	-	10.0	20.0	mT
Release Point	B_{RP}	$V_{CC}=24\text{V}$, $R_L=10\text{k}\Omega$, $B < B_{RP}$	3.0	5.0	-	mT
Hysteresis	B_H	$I_{OUT}=25\text{mA}$, $B > B_{OP}$	-	5.0	-	mT

9 Characteristic Curves (Type UA)

Supply Current (Off) versus Ambient Temperature

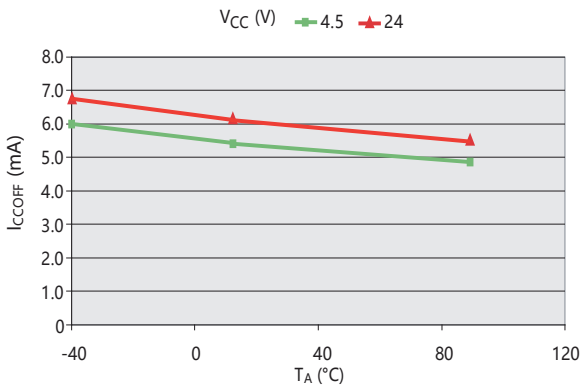

Supply Current (Off) versus Supply Voltage

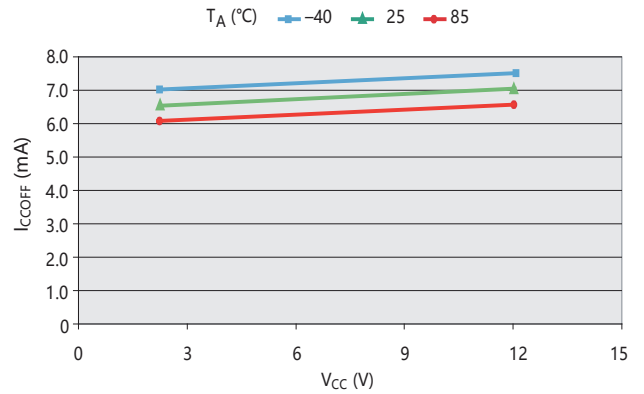

Low-level Output (On) versus Ambient Temperature

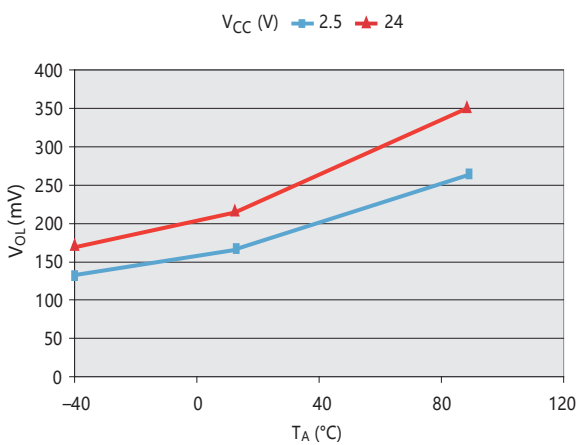

Low-level Output (On) versus Supply Voltage

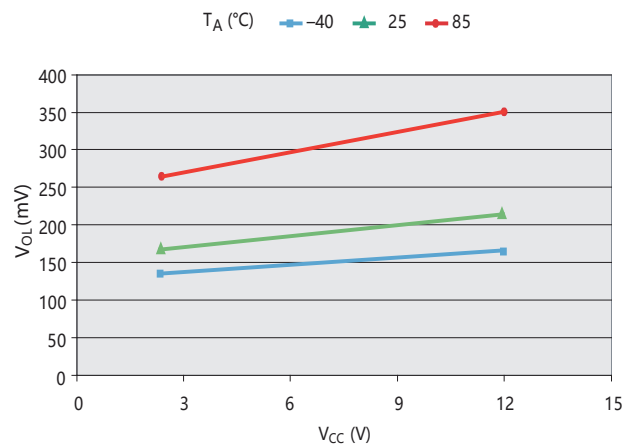

Operating and Release Point versus Ambient Temperature

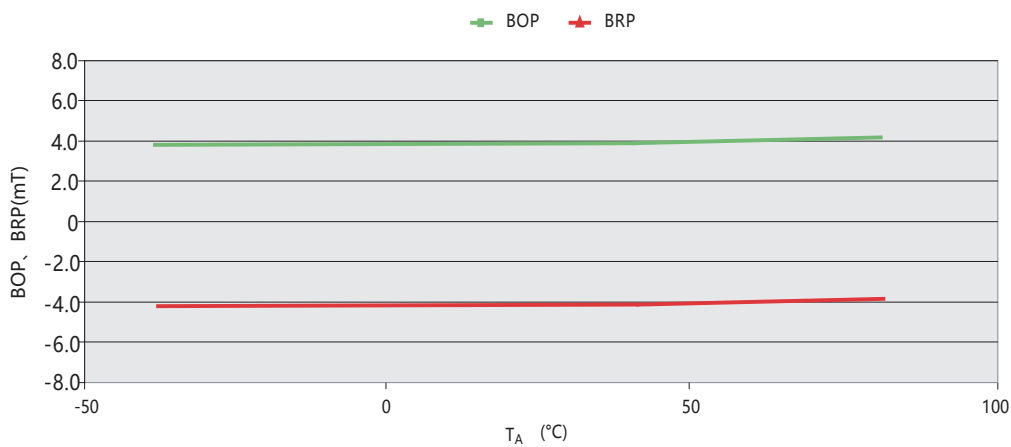

10 Magnetic Behavior

South Pole Active

When the “S” pole faces the sensor’s mark surface and is closed to it ($B \geq B_{OP}$), the terminal V_{O1} outputs a low level and the terminal V_{O2} a high level; when the “N” pole faces sensor’s mark surface and is closed to it ($B \leq B_{RP}$), terminal V_{O1} outputs a high level and the terminal V_{O2} a low level. Stable hysteresis ($B_h = B_{OP} - B_{RP}$) ensures stable switch status. The magnetoelectric conversion characteristics of AH4059 are shown in the figure:

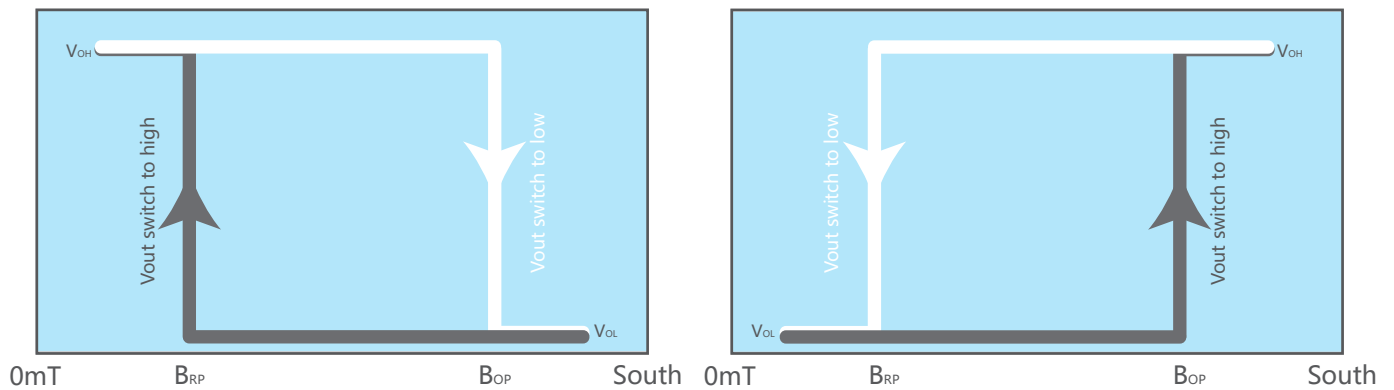

11 Package Information

TO-94

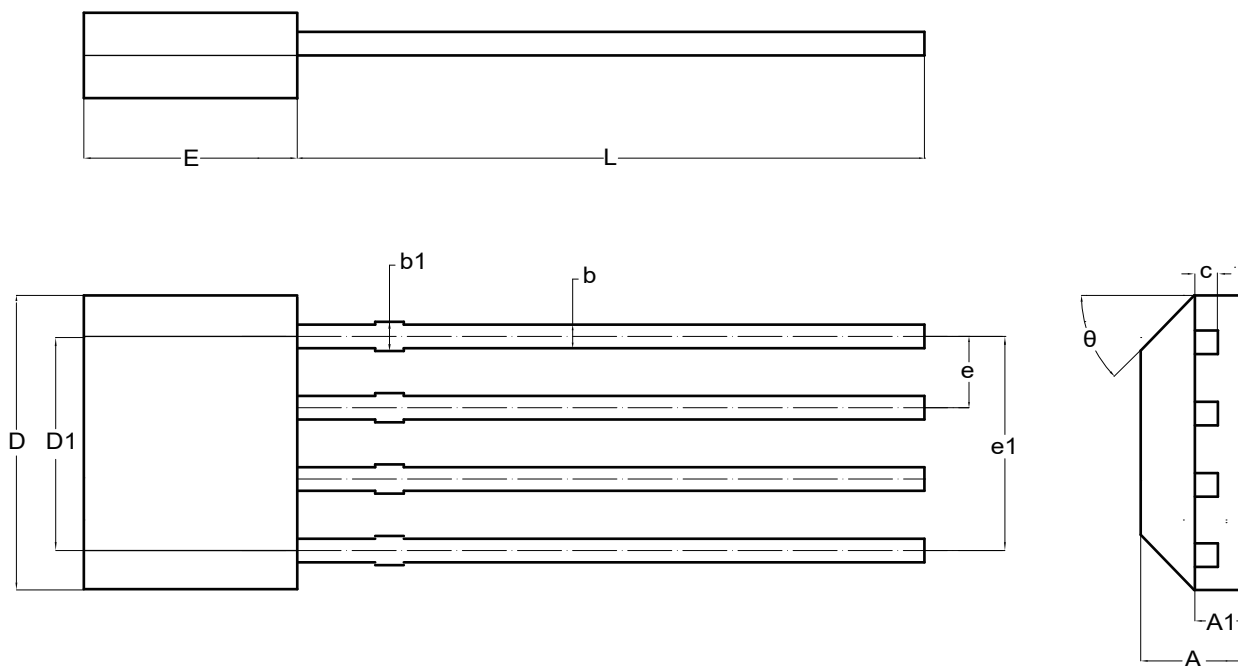

Symbol	Dimension (Unit: mm)	
	Min.	Max.
A	1.400	1.800
A1	0.700	0.900
b	0.360	0.500
b1	0.380	0.550
c	0.360	0.510
D	4.980	5.280
D1	3.780	4.080
E	3.450	3.750
e	1.270TYP.	
e1	3.710	3.910
L	14.900	15.300
θ	45°TYP.	

12 Marking Information

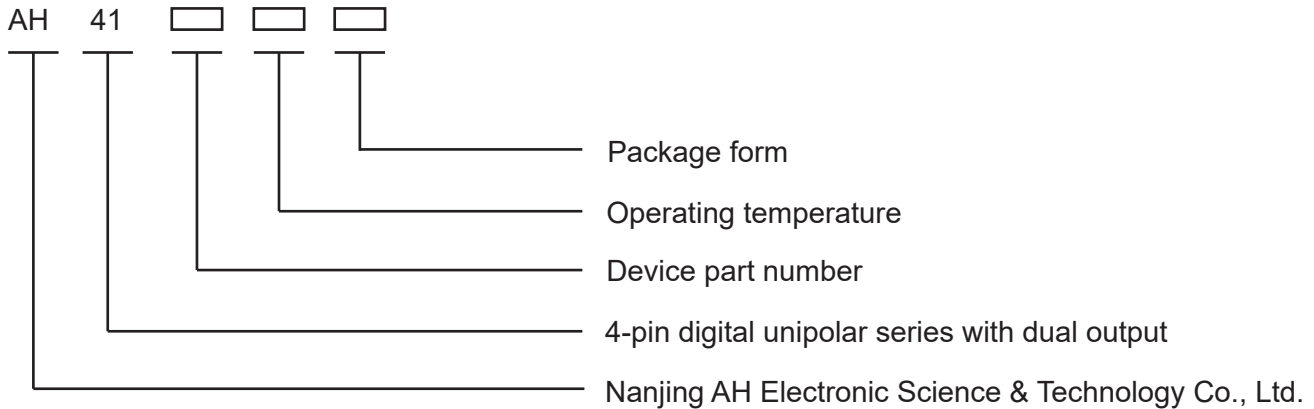

Copyright 2003~2020 Nanjing AH Electronic Science & Technology Co., Ltd.
Nanjing AH Electronic Science & Technology Co., reserves the right to improve the performance, reliability or manufacturability of its products at any time according to detailed specifications. Before placing an order, the user is cautioned to verify that the information being relied upon is up-to-date.

AHNP's products are not to be used in any life support devices or systems (including but not limited to the listed devices or systems), in which a failure can reasonably be expected to cause bodily harm.

The information included herein is believed to be accurate and reliable. However, Nanjing AH Electronic Science & Technology Co., assumes no responsibility for its use; nor for any infringement of patents or other rights of third parties which may result from its use.

Learn more about our products for your application, please contact us:

nianrong@ahest.com